

# Harness the *power* of



The world's healthiest, coolest, quietest most energy-efficient evaporative air conditioners ever!<sup>1</sup>

**100%** *healthy*  
fresh filtered air  
for total comfort

up to  
**80%** *cheaper*  
to run than reverse  
cycle air conditioning<sup>2</sup>



1972-2022

World-leading climate control solutions



Evaporative Air Conditioning

2023



# Harness the *power* of nature.

## At Seeley, we harness the power of air and water

There's a natural attraction between air and water that is very powerful...

Outside, these forces of nature live all around us. But, what if we could harness this power inside too?

Our evaporative air conditioning technology has been inspired by nature with ingenious design, incredible reliability and unsurpassed cooling performance using 100% fresh outside air - the only air to breathe!

Today, you can harness that power too.

Seeley International is renowned for world-class design and innovation, striking that delicate balance between form and function, just like nature.

We have a range of evaporative coolers that would seamlessly integrate with all roof lines without compromising on comfort, quality or environmental credentials, through to our traditional range that also deliver efficient, natural cooling for long lasting comfort.

Since day one, over 50 years ago, our company has been about challenging mindsets and stretching the imagination. Trust, reliability and innovation have been the cornerstones to success. It's no coincidence that Seeley International is the most awarded air conditioning manufacturer in Australia. We export our amazing products all around the globe.

At Seeley International, we don't settle for ordinary, and neither should you.

*Frank Seeley*

AM, DUniv *Flin*, FAICD  
Founder and Executive Chairman



Harness the *healthiness* of 100%  
fresh air - the *only* air to breathe!

## Award Winning Company

Seeley International consistently wins awards each year for new product design, innovation and environmental friendliness. Recent awards include:



melbourne  
design  
awards



sydney  
design  
awards



Front cover:

1. Based on published research articles, NATA certified laboratory test results and publicly sourced data.
2. Seeley International's calculation based on approximate running cost figures from publicly sourced data.

Australian *designed, made*  
and **owned!**



Bruce - Production Operator

## Built by Australians, for the harsh Australian climate

Seeley International is proudly a 100% Australian owned company, designing and manufacturing world-leading air conditioning products for Australia and the world. As Australia's largest air conditioning manufacturer, we are a global leader in developing ingenious, energy-efficient cooling and heating products. Being made in Australia, you can rely on build quality, longevity and the availability of parts and after sales service, for many years to come. We're extremely passionate, and dedicated to strengthening the Australian economy, supporting local employment and building on the skills of our workforce.

# Why evaporative air conditioning?

The most healthy and energy efficient cooling experience for **everyone** in your home!

Evaporative air conditioning delivers a natural, exceptionally healthy cooling experience in the place where people spend **most** of their time - **HOME**. Bringing an **endless supply** of **100%** fresh, cool, filtered outside air into the home, not taking moisture from the air, which **combats** dehydration. It is environmentally friendly as it does not use harmful refrigerants containing HCFC's or HFC's.

It produces less CO<sub>2</sub> emissions than reverse cycle air conditioning due to its efficient, low energy use whilst cooling your whole home, and everyone in it. **PLUS evaporative air conditioning** drives everyone's **second-hand air out of the home**, along with the brain-numbing CO<sub>2</sub> which they all exhale - making this the **HEALTHIEST** air conditioning.

**It's kind to you, kind to the environment, kind to your cash-flow, making evaporative cooling the NATURAL CHOICE.**



## The healthiest choice

Improving the health, wellbeing and vitality of the whole family. Not taking moisture from the air, which combats dehydration.



## Lowest running cost in Australia

Up to 80% cheaper to run<sup>2</sup>. Save up to 80% on energy bills when compared to a reverse cycle air conditioner.



## Fresh, cool clean air

Delivers **100%** fresh, filtered outside air, expelling the stale recycled air, and naturally cooling your **whole** home.



## Quiet to run

Ask your dealer for a demonstration - see how **cool and whisper quiet** it is!



## Built to last

Quality that lasts. Up to 7 years comprehensive warranty<sup>3</sup>.



## Australian designed, made and owned!

Manufactured by family owned Seeley International, Australia's largest air conditioning manufacturer.



## Environmentally friendly

Produces up to 80% less CO<sub>2</sub> emissions<sup>-</sup> - that's the equivalent of **planting 16 gum trees!**<sup>-</sup>  
<sup>-</sup>Refer to page 9.



## NATA testing

NATA accredited laboratory test results substantiate superior product performance claims.



## Technology that puts you in control

MagIQTouch<sup>®</sup> controller technology for complete control of your comfort at home.



## Low maintenance

Innovative design, minimising long term servicing.



## Ultimate lifestyle

Perfect for alfresco living and busy families where children and pets keep coming in and out.



## Minimal water usage

Evaporative air conditioning uses up to **94% less water** per year than a shower<sup>4</sup>.

- Seeley International's calculation based on approximate running cost figures from publicly sourced data. Comparison with 1.5 star not zoned ducted refrigerative system in a large size (220m<sup>2</sup>) 2-star pre 2005 house in a Melbourne climate, cooling all day on the weekend and in the mornings and evenings when internal temperatures are high, and an electricity tariff of 31.9c/kWh. Negligible water cost excluded.
- The 7 year comprehensive warranty is available exclusively (i.e. only) from Seeley International participating dealers. The warranty has terms and conditions, including the requirement for servicing of the product in accordance with the owner's manual. In the fourth year the service must be performed by Seeley International or its appointed nominee.
- Water use calculations for shower are based on shower water use for 4 people, 7 mins per person per day at 9L/min, over twelve months, calculated at 91,980 L. Water use calculations for Braemar unit LCQ450 evaporative air conditioner over twelve months are 5,405 L.

# Start enjoying **world-leading** evaporative and become... **Healthier, Wealthier and**

## Seeley International and your health

Australians spend between 80 to 100% of their time indoors, either at work or at home<sup>22</sup>, which demonstrates how important Indoor Air Quality (IAQ) is, when it comes to **your own health and well-being**, your ability to concentrate and be energetic and productive.

Indoor Air Quality (IAQ) is a **high priority** for buildings and work spaces under the building code, so it should also be taken seriously in the home environment, especially as it relates to the health and comfort of building occupants... being you and your family! Understanding and controlling common pollutants indoors, including CO<sub>2</sub> can help reduce your risk of indoor health concerns.

Evaporative air conditioning is better for you and your family. Here's why:

### Removes CO<sub>2</sub> and other indoor pollutants

Evaporative air conditioners **continually cool and deliver 100% fresh, filtered, OUTSIDE AIR**, whereas reverse cycle air conditioners **re-circulate air** that you've **all been breathing and living in** for hours, and maybe days. This re-circulated air contributes to a build-up of CO<sub>2</sub> in the home and CO<sub>2</sub> is known to have adverse effects on human health and well-being.

### Maximum air replacement

Our evaporative air conditioners **replace** the stale air in your **whole** home every two minutes<sup>21</sup>. That's how effective they are in pushing out stale air through open windows and doors, while the system is cooling your whole home.

### Perfect balance of air moisture

Evaporative air conditioning naturally moisturises the air so **NO-ONE** suffers from the **dryness** that comes with reverse cycle air conditioning.

### No additional installation costs with zoning

Evaporative air conditioning does not need to be zoned to maximise operating efficiency and energy savings, so your whole home can be **ventilated** with fresh cool outside air, at any time of day or night.



21. Based on airflow data (litres/sec) from Braemar LCQI and Breezair XTR coolers in an average house with 2.4m ceilings and floor area of 150m<sup>2</sup>.

22. Source: <https://www.health.vic.gov.au/health-officer/healthy-indoor-environments> (2022)

# air conditioning Wiser - Environmentally!

## Up to 80% cheaper to run

Using highly efficient inverter motors, our evaporative air conditioners deliver savings of up to 80% on your energy bills when compared to ducted reverse cycle systems.

### Running costs per year<sup>2</sup>

Compared to a ducted reverse cycle system

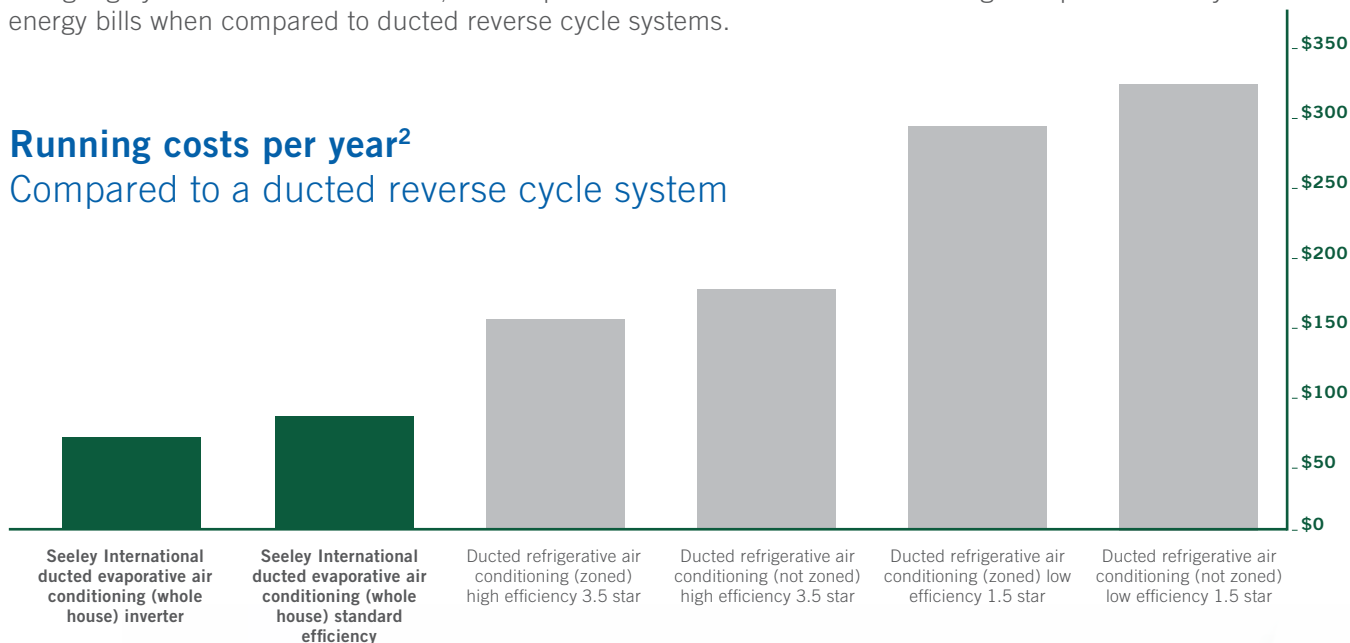

So if you want ultra-cool, healthy, 100% fresh air, around the clock with huge power savings, you can **have** it! But **only** if you harness the power of Breezair, Braemar or Coolair.



### Incorporating **InvertaCool®** technology

- Quieter operation.
- Greater air flow control.
- Ultra-energy efficient, lower carbon emissions.
- Lower power bills.



2. Seeley International's calculation based on approximate running cost figures from publicly sourced data. Comparison with 1.5 star not zoned ducted refrigerative system in a large size (220m<sup>2</sup>) 2-star pre 2005 house in a Melbourne climate, cooling all day on the weekend and in the mornings and evenings when internal temperatures are high, and an electricity tariff of 31.9c/kWh. Negligible water cost excluded.

# Minimal water usage



Our water saving features:

- Superior water distribution system
- Water quality monitoring
- Auto-Clean™ - Automatic water drainage

The result: Minimum water usage for maximum, fresh cooling power.

## Water consumption comparison across household appliances<sup>4</sup>

### Seeley Evaporative A/C<sup>4</sup>

Based on 12 months usage: **5,405 L/year**

### Washing machine

Based on 70L/load, 5 loads per week: **18,200 L/year**

### Toilet

35 flushes per week, per person in a 4 person household, average 5L per flush: **36,400 L/year**

### Garden Watering (including sprinklers)

120 mins per day at 20 litres per minute - 2x per week and 3x in summer months: **57,600 L/year**

### 9L/min water efficient shower head

4 people daily, taking 7 minute showers: **91,980 L/year**





# Reduce your carbon footprint



The power consumption of just one ducted refrigerated air conditioner can result in up to 1.4 tonnes of harmful CO<sub>2</sub> being pumped into the atmosphere each year. By purchasing a Seeley International evaporative air conditioner, which uses water, a **renewable resource**, to cool, you'll **reduce your impact on the environment** by producing up to **80% less CO<sub>2</sub> emissions**<sup>5</sup>, when compared to a ducted reverse cycle air conditioner.

## CO<sub>2</sub> Emissions (kg/Yr)<sup>5</sup>

CO<sub>2</sub> savings equivalent to planting 16 gum trees!<sup>6</sup>

Compared to a ducted reverse cycle system

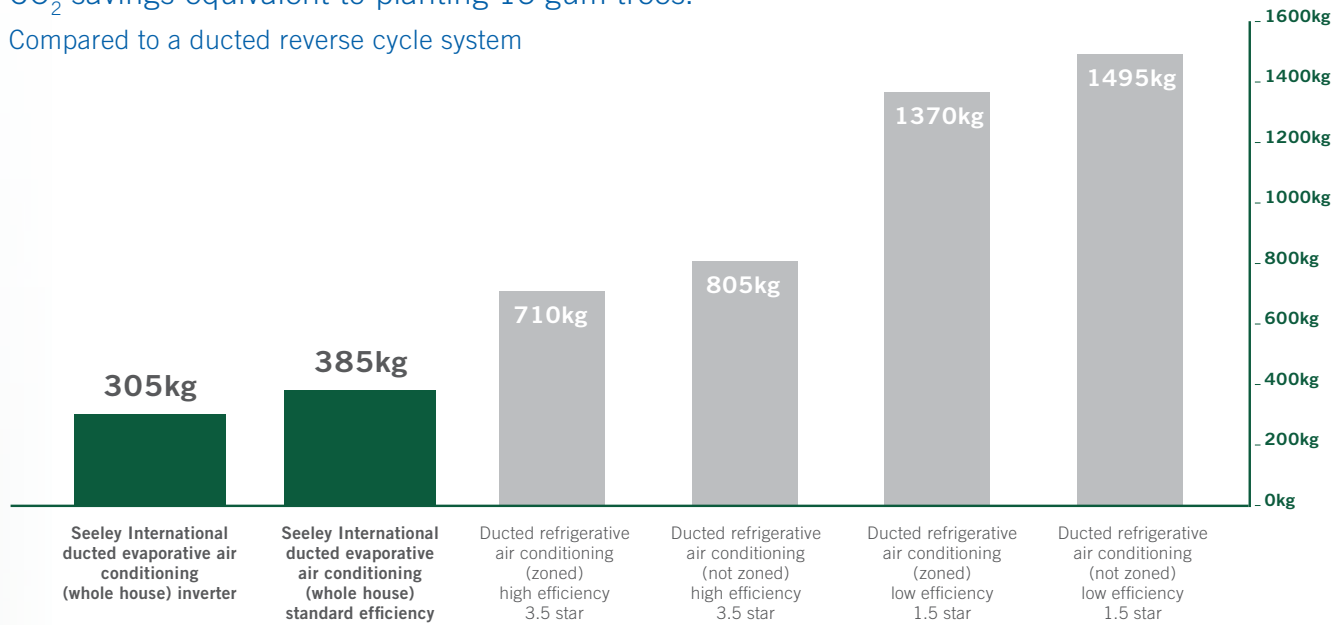

## How do I choose?

The airflow, and size of the area you wish to cool, will be the largest determinants of which model is best suited to your needs. Whilst it may seem that bigger can only be better, a correctly sized air conditioner for your home will run far more efficiently, which equates to maximised electricity cost savings.

- **Is your home well insulated?** This is a key consideration, as it impacts your home's ability to maintain its temperature. A well insulated home may need a lower capacity unit, in comparison to a poorly insulated home.
- **What climate will your home operate in?** The hotter the climate, the greater the demand on your air conditioning.
- **What additional benefits are important to you?** Seeley International evaporative air conditioners offer additional technology benefits like winter seals, SuperStealth® fans, inverter motors, water savers, and architecturally designed units for greater aesthetic appeal. (Refer to product selection guide on page 24 for more information.)

4. Water use calculations for Braemar unit LCQ450 evaporative air conditioner over twelve months are 5,405 L. This comparison is based on usage in an average-size Australian home with 4 occupants.

5. Seeley International's calculation based on approximate greenhouse gas emissions figures from publicly sourced data. Comparison with 1.5 star not zoned ducted refrigerative system in a large size (220m<sup>2</sup>) 2-star pre 2005 house in a Melbourne climate, cooling all day on the weekend and in the mornings and evenings when internal temperatures are high.

6. This is an estimate based on the CO<sub>2</sub> calculation above and using the data from forestlearning.edu.au, 'Carbon and its storage in forest and wood products' article, published 2011. Calculation based on a spotted gum tree that sequesters 72kg CO<sub>2</sub>/YR.

Inspirational comfort, combined with ultra-energy efficiency!

Harness the  
*power* of  
**Braemar**  
By SEELEY INTERNATIONAL 



## A reputation built on quality and endurance

Founded in 1938 and being the oldest of Seeley International's brands, Braemar remains one of Australia's most recognised and trusted brand names today.

Backed by an 80 year history of innovation and success, the Braemar range is the recipient of many industry awards, including:

- The prestigious Good Design Awards in 2018 for the Braemar Evolution range.
- The Product Design Award in 2016 for the SuperStealth®
- Winner of the prestigious 2016 Australian Business Award.

These Awards reflect Braemar's commitment to sustainability; recognising its reduced energy usage, ultra-low noise, and reduced impact on the environment.

### Braemar benefits:

- SuperStealth® axial fan
- InvertaCool® motor
- Trusted brand for over 80 years



This warranty has terms and conditions, including the requirement for regular servicing of the product in accordance with the owner's manual.

Harness the *brilliance* of  
Braemar Evolution!



The coolest, compact, low profile air conditioner in the world!

# Braemar range



## Evolution

With its low profile, superb design, the Braemar Evolution unobtrusively sits below the roof ridgeline to blend seamlessly with your home.

- InvertaCool® motor, using far less energy than a standard motor.
- SuperStealth® axial fan.
- Ultra quiet.
- 24% more active Chillcel® cooling pad area than the Paradigm™.
- **The Lowest Profile, Highest Performance Range available!**

Available colours<sup>8</sup>



GREY



TERRACOTTA

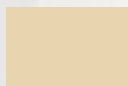

BEIGE

8. Colours may vary.

# Braemar range



## SuperStealth®

### Invertair® Series

The world's first high performance inverter axial evaporative air conditioner with the highest cooling capacity and energy efficiency in the Braemar range.

- Ultra-quiet cooling.
- Outstanding high-performance cooling.
- Patented ultra quiet SuperStealth® fan (quieter than the standard stealth fan).

Available colours<sup>8</sup>

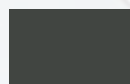

GREY



TERRACOTTA

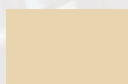

BEIGE

8. Colours may vary.



## Paradigm Series™

### Proven performer

- Braemar quality and reliability.
- High efficiency and cooling performance.
- Premium water management system.

Available colours<sup>8</sup>



GREY



TERRACOTTA



BEIGE

8. Colours may vary.

## Features and benefits

### Exceptional water distribution

The water distribution system includes a combination of pressurised and free-flowing water systems, providing:

- Even water flow over the sides of the top panel, ensures maximum pad area and maximum cooling at all times.
- Australian designed, world patented, free flow, water distributor ensures constant, even pad saturation increasing the cooling capacity and outperforming competitor products.

### Breakthrough Black Magic® MINI-CELL<sup>7</sup> CHILLCEL<sup>®</sup> pad technology

- The only evaporative cooling medium of its kind. Fully manufactured in Australia to address the harsh Australian climate. It's an **absolute out-performer!**
- Exclusive small cell design provides cutting-edge, high capacity cooling in a class of its own.
- Maintains our global leading Mini-Cell<sup>7</sup> Chillcel<sup>®</sup> pad technology, which increases surface area of the **fully wetted pads** by 25%, dramatically increasing cooling capacity and efficiency - **BEYOND BELIEF!**
- **Black Magic<sup>®</sup> MINI-CELL<sup>7</sup> CHILLCEL<sup>®</sup> pads** deliver superlative cooling and transformational aesthetics to your home, enabling the unit to blend seamlessly into its surroundings.

### Power control module helps save water and power

- Microprocessor constantly analyses water quality, water consumption and power output.

### Tornado<sup>®</sup> pump that won't block

- Australian designed and manufactured.
- Exceptional reliability in extreme conditions.
- Dual directional – it can't block!



### Auto Cleanse™ - Auto water draining keeps your system clean

- Empties the reservoir automatically when system is not in use, leaving it clean and dry.
- Ensures the system always operates at maximum efficiency, while using the minimum amount of water.
- Helps to reduce seasonal maintenance<sup>9</sup> as required by some other brands.

7. Patent pending.

9. Seasonal maintenance does not replace regular maintenance of the unit as required for peak performance.





## UV stabilised and corrosion free

- The cabinet and water reservoir components are injection moulded structural foam polypropylene (Permatuf®) and are UV stabilised and non-corrodible.



## SuperStealth® Technology (Evolution & SuperStealth® models)

- Advanced aerodynamic design.
- SuperStealth® InvertaCool® motor and SuperStealth® fan for high energy efficiency and whisper quiet operation.



## WaterManager™ saves water

- Uses the minimum amount of water to achieve high efficiency cooling.
- Water quality monitoring to maximise water savings.
- Keeps your system clean on the inside.

## AutoWinterseal® reduces draughts and dust

- Automatically closes off the air conditioning ducts when not in use.
- Reduces winter chills entering your home.
- Ensures comfort all year round.

## Bushfire Protection Firewall Ember Screen (optional extra)

- Helps guard against ember attack in bushfires. Turn to **page 26** for more information.

# Affordable, effective cooling

## Harness the *power* of **coolair** By SFFI FY INTERNATIONAL

### Accessible evaporative air conditioning

The Coolair Brand became part of the Seeley International suite in 1997 and was quickly redeveloped to incorporate the all-plastic, corrosion-free construction which Seeley had pioneered.

The brand maintains its ethos of affordable effective cooling; presenting a good, value for money unit for those wanting to enjoy the benefits of evaporative cooling, without the cost of more advanced features.

### Unit Snapshot:

- Variable speed motor
- Axial fan
- Automatic drain valve optional



The warranty has terms and conditions, including the requirement for regular servicing of the product in accordance with the owner's manual. Coolair 5 Year only warranty applies to products purchased from October 1st 2020.

# Coolair range

## CPQ

### Series

Coolair Evaporative air conditioners are very affordable, representing the **CHEAPEST-HIGHEST-VALUE-FOR-MONEY** coolers, which do not compromise on the renowned Seeley performance.

- Variable speed motor.
- State of the art axial fan.
- Operates with a bleed valve water management system - especially suitable for harsh water quality regions.
- Drain valve water management can be fitted as optional.
- Proven track record for reliability and longevity.

Available colours<sup>8</sup>



## Coolair... Australia's greatest value for money home cooling!

- ✓ Durability ensures long term trouble-free comfort!
- ✓ Efficiency, save up to 75% on energy costs<sup>2</sup>.
- ✓ Australian designed, made and owned!
- ✓ Natural fresh, cool, clean, filtered air.
- ✓ NATA accredited test results substantiate superior product performance.
- ✓ Alfresco living with options for security vents so doors and windows can remain closed.

2. Seeley International's calculation based on approximate running cost figures from publicly sourced data. Comparison with 1.5 star not zoned ducted refrigerative system in a large size (220m<sup>2</sup>) 2-star pre 2005 house in a Melbourne climate, cooling all day on the weekend and in the mornings and evenings when internal temperatures are high, and an electricity tariff of 31.9c/kWh. Negligible water cost excluded.

8. Colours may vary, Terracotta made to order.

# Coolair

## Features and benefits

### Exceptional water distribution increases cooling effect

Coolair's unique patented water distribution system means no clogging of the filter pads.

- Clever high efficiency pad wetting system.
- Total pad saturation for total cooling.
- **High performance cooling day and night.**

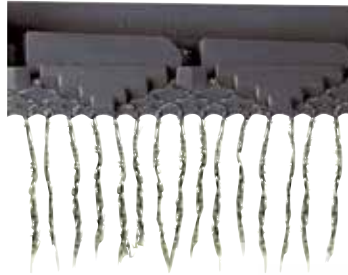

### Tornado® pump that won't block

- Australian designed and manufactured.
- Built to outlast other less efficient conventional style pumps.
- Dual directional – it can't block!



### Stealth® fan is whisper quiet

- Advanced aerodynamic design.
- Super quiet in operation.
- Produces a beautifully cool, quiet, refreshing breeze, and at a fraction of the running costs of alternatives!



### Breakthrough Black Magic® Mini-Cell<sup>7</sup> Chillcel® pad technology

- The only evaporative cooling medium of its kind. Fully manufactured in Australia to address the harsh Australian climate. It's an absolute out-performer!
- Exclusive small cell design provides cutting-edge high capacity cooling.
- Maintains our global leading Mini-Cell<sup>7</sup> Chillcel® pad technology, which increases surface area of the **fully wetted pads** by 25%, dramatically increasing cooling capacity and efficiency - **BEYOND BELIEF!**
- **Black Magic® MINI-CELL<sup>7</sup> CHILLCEL® pads** deliver superlative cooling and transformational aesthetics to your home, enabling the unit to blend seamlessly into its surroundings.



7. Patent pending

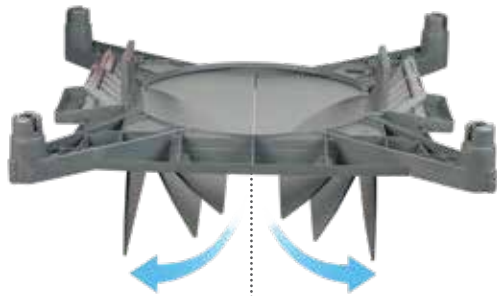

### AutoWinterseal® reduces draughts and dust

- Automatically closes off the air conditioning ducts when not in use.
- Reduces winter chills entering your home
- Ensures comfort all year round.

### Highly durable and non-corrodible outer casing

- Visually discreet, low profile.
- Integrates unobtrusively with the roof line.
- High performance Permatuf® polymer construction.
- Highly durable, will not corrode or rust.
- Available in a range of contemporary colours.



### Auto water draining keeps your system clean (optional)

- Reduces the amount of seasonal maintenance with this optional feature<sup>10</sup>.
- This clever device conserves water by retaining the system's water for up to 72 hours of non-operation.



### Flexible control with MagIQcool®

The Coolair MagIQcool® controller is incredibly easy to use.

- Set your preferred temperature level on the clever wall mounted control and Coolair will do the rest - quickly, cleanly and reliably.
- Maintain your desired comfort level with four convenient modes to choose from - cool, vent, auto and timer.



### Optional extra: MagIQtouch® controller Touch screen technology

10. Regular maintenance (typically every two years for domestic use) is still required.

# Harness the *simplicity* of **MAGIQTOUCH®** controller

## Touch screen technology

Smart, sophisticated and incredibly intuitive, your MagIQtouch® controller is an upgrade from the manual controller and makes operating your evaporative air conditioner a breeze. Control the temperature, fan speed and many more features on a user friendly touch screen. The discreet and modern design will blend seamlessly into the décor of your home.



Temperature control

Current temperature  
Target temperature

## Main features



### Program mode

Programmable 7 day, 4 time period program, customisable to suit your lifestyle (including a temporary over-ride function).



### Energy saving quiet night mode

A comfortable night's sleep that won't cost the earth. The energy saving quiet night mode automatically reduces fan speed during the night for even greater economy at lower noise levels.



### Touch screen functionality

All functions and operations are only a touch away, with the easily navigated interface.



### Cooling & Heating

Control both your cooling and heating from one MagIQtouch® controller.



### Auto-clean™ function

World's first fully automated pad cleansing capability enables you to set and forget, ensuring your cooling pads remain clean, fresh and functional all summer long, season after season<sup>12</sup>.



### Useful settings

Access additional features such as child lock, and servicing information.

## Optional extra: MagIQtouch® air sensor

The MagIQtouch® air sensor monitors temperature and humidity levels. It allows you to mount your MagIQtouch® controller in the most convenient place in your home, as the MagIQtouch® air sensor will then take over temperature control from the MagIQtouch® controller. This can then be located in the best place in the house to ensure ultimate cooling comfort for everyone.



<sup>12</sup>. Only for cooler models fitted with the water management system. Ask your dealer for further information.

# Harness the *power* of Wi-Fi and wireless

## Controller upgrade options

If you choose a MagIQtouch® controller you receive a touchscreen that is hard-wired into your home, fixed to your wall, where it best suits your needs. This model of MagIQtouch® controller can be upgraded to a Wi-Fi enabled touchscreen.

### Option 1



#### Wi-Fi enabled<sup>16</sup> touch screen:

- **Take complete control of your comfort at home, at all times.**
- Upgrade to a Wi-Fi module to work with your wired-in MagIQtouch® controller<sup>17</sup>, enabling you to control your cooling directly from your personal device through our smart app.
- The smart app<sup>13</sup> is available on Android and IOS devices.
- Integrate into voice activated smart home controls like Google Home<sup>14</sup> and Amazon Alexa<sup>15</sup>.



Available for download now on iOS and Android

### Option 2

Unable to have a hard-wired controller? No problem, MagIQtouch® also has a wireless touch screen option.



#### Wireless touch screen:

- Battery operated wireless controller using Radio Frequency technology.
- Ideal for renovations, or where access for cabling is limited.
- Easier to install, the RF option also provides up to 2 primary controllers.
- Can control the entire system from 2 locations, rather than 1; an ideal solution for larger, or two storey homes.

13. Requires MagIQtouch® wall control, MagIQtouch® Wi-Fi smart kit and MagIQtouch® account to operate. Additional costs may apply.

14. Requires Wi-Fi, Google account and a compatible device. Google and Google Home are trademarks of Google LLC. Additional costs may apply. Not all Google Home functionality may be available, please consult Seeley International for more details.

15. Requires Wi-Fi, Amazon account and a compatible device. Additional costs may apply. Not all Amazon Alexa functionality may be available, please consult Seeley International for more details.

16. Requires MagIQtouch® Wi-Fi kit, compatible MagIQtouch® controller and MagIQtouch® account to operate. Additional costs may apply.

17. MagIQtouch® Wi-Fi Module is not compatible with MagIQtouch wireless controller. Existing installations including a MagIQtouch® controller may need to be upgraded if purchasing the Wi-Fi module. Additional costs may apply.

# Product Selection Guide

	Braemar Evolution			Braemar SuperStealth®				Braemar Paradigm		
	LPQI350	LPQI450	LPQI550	LCQI250	LCQI350	LCQI450	LCQI550	LCQ350	LCQ450	LCQ550
Cooling Capacity (kW)	10.4	11.8	13.2	8.1	9.9	13.5	14.3	10.2	13.2	14.1
Airflow (L/s @ 80Pa)	2010	2390	2850	1500	1990	2620	3070	1980	2560	2810
Nominal motor power (W)	430	600	950	340	430	600	950	430	600	950
AutoWinterseal®	✓	✓	✓	✓	✓	✓	✓	✓	✓	✓
Advanced salinity control management system	✓	✓	✓	✓	✓	✓	✓	✓	✓	✓
Auto drain valve	✓	✓	✓	✓	✓	✓	✓	✓	✓	✓
Black Magic® Mini-Cell® Chillcel® technology	✓	✓	✓	✓	✓	✓	✓	✓	✓	✓
Low profile sloping base	✓	✓	✓							
Permatuf® polymer molded cabinet	✓	✓	✓	✓	✓	✓	✓	✓	✓	✓
Standard bleed water management										
SuperStealth® fan & InvertaCool® inverter motor	✓	✓	✓	✓	✓	✓	✓			
High static fan (160-240pa)	✓	✓	✓	✓	✓	✓	✓			
Tornado® pump	✓	✓	✓	✓	✓	✓	✓	✓	✓	✓
Double pump outlet	✓	✓	✓							
WaterManager™ system	✓	✓	✓	✓	✓	✓	✓	✓	✓	✓
MagIQtouch® controller available	✓	✓	✓	✓	✓	✓	✓	✓	✓	✓
MagIQtouch Wi-Fi module or RF controller options available	✓	✓	✓	✓	✓	✓	✓	✓	✓	✓
MagIQcool® wall controller available								✓	✓	✓

## Braemar Technical Specifications

Model	Cooling capacity (kW)	Airflow (L/s) at 80Pa <sup>11</sup>	Nominal motor power (W)	Length (mm)	Width (mm)	Height – Front (mm)	Height – Rear (mm)	Operating weight (kg)
Evolution LPQI350	10.4	2010	430	1150	1150	730	380	86
Evolution LPQI450	11.8	2390	600	1150	1150	730	380	86
Evolution LPQI550	13.2	2850	950	1150	1150	730	380	86

Model	Cooling capacity (kW)	Airflow (L/s) at 80Pa <sup>11</sup>	Nominal motor power (W)	Length (mm)	Width (mm)	Height (mm)	Operating weight (kg)
SuperStealth LCQI250	8.1	1500	340	1150	1150	685	88
SuperStealth LCQI350	9.9	1990	430	1150	1150	685	88
SuperStealth LCQI450	13.5	2620	600	1150	1150	835	91
SuperStealth LCQI550	14.3	3070	950	1150	1150	835	91
Paradigm LCQ350	10.2	1980	430	1150	1150	685	80
Paradigm LCQ450	13.2	2560	600	1150	1150	835	89
Paradigm LCQ550	14.1	2810	950	1150	1150	835	91

## Coolair Technical Specifications

Model	Cooling capacity (kW)	Airflow (L/s) at 80Pa <sup>11</sup>	Nominal motor power (W)	Width (mm)	Depth (mm)	Height (mm)	Operating weight (kg)
CPQ450	8.0	1570	340	1150	1150	685	78
CPQ700	9.5	2000	430	1150	1150	685	79
CPQ850	11.8	2560	600	1150	1150	835	87
CPQ1100	13.3	2710	750	1150	1150	835	89

### InvertaCool® technology used in these models

Refer to page 7 for details of benefits.

7. Patent pending.

11. Airflow performances at 80Pa - the equivalent duct static pressure of typical ducted residential multiple outlet installations. The above data was drawn from Meridian Test Laboratory's test analysis. The testing was performed by a NATA accredited laboratory to the requirements of the Australian standard AS2913-2000 "Evaporative Air Conditioning Equipment." Achievable with ambient 38 °C DB, 21 °C WB, room temperature 27.4 °C.



Coolair CPQ			
CPQ450	CPQ700	CPQ850	CPQ1100
8	9.5	11.8	13.3
1570	2000	2560	2710
340	430	600	750
✓	✓	✓	✓
optional	optional	optional	optional
✓	✓	✓	✓
✓	✓	✓	✓
✓	✓	✓	✓
✓	✓	✓	✓
✓	✓	✓	✓
✓	✓	✓	✓



# Additional Information

## Combined heating and cooling solution

**A Seeley International ducted gas heater will complement your evaporative cooling system:**

- Warm and cosy in winter; fresh and cool in summer!
- MaglQtouch® controller will seamlessly control **both** heater and cooler systems.
- Braemar has the highest efficiency star ratings in Australia for ducted gas heating<sup>18</sup>.



## Keep your home secure

**Did you know you can cool your home without leaving your doors and windows open?**

Cost effective and easy to install, the **Security Relief Vent™** allows you to run your evaporative air conditioner while you are out, with all your windows and doors safely closed and locked.

Your home will **stay** cool, because the **cool** exhaust air is released into the hot roof space, cooling everything while you're out.

When you return home, if you wish, simply open up your windows and doors as normal - either way, you will **maintain** the delivery of fresh, cool air **throughout** your home.



## Bushfire protection

**Firewall Ember Screen (optional extra)**

- Helps guard against ember attack in bushfires.
- Made from non-combustible mesh.
- Maximum aperture of 2mm.
- Can be fitted to existing cooler pad frames.
- Minimal reduction in air flow of around 5%.
- To meet BAL ratings, the cooler **also** requires a Firewall Auto Seal installed.
- Fitting both Ember Screen and Auto Seal to comply with BAL ratings will reduce airflow by up to 15%.

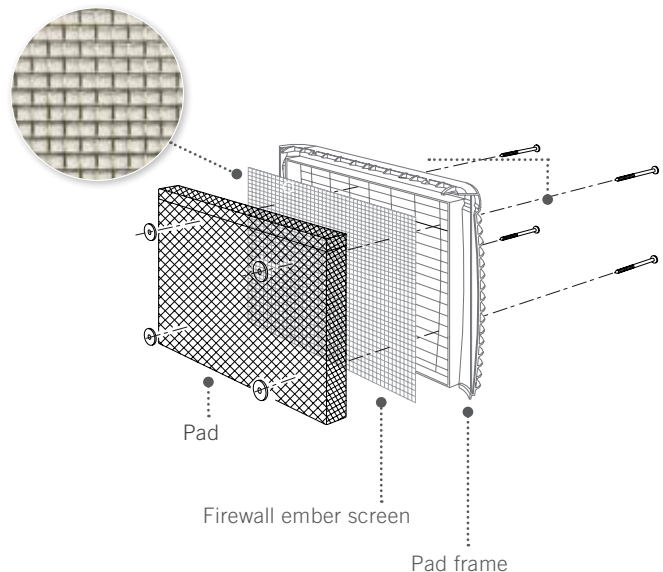

# Warranty Terms



## 7 Year Warranty - Braemar

7 year Comprehensive Warranty<sup>19</sup>, 10 year cover on all structural components, plus a hefty 25 year cover against corrosion, on its Permatuf® cabinet.

19. The 7 year comprehensive warranty is available **only** if the product is first purchased from [Seeley International](#), by Seeley International Participating Dealers **and not** through distributors/wholesalers or trade installers. Warranty is calculated at 7 years from date of purchase.

The warranty has terms and conditions, including the requirement for regular servicing of the product in accordance with the owner's manual.

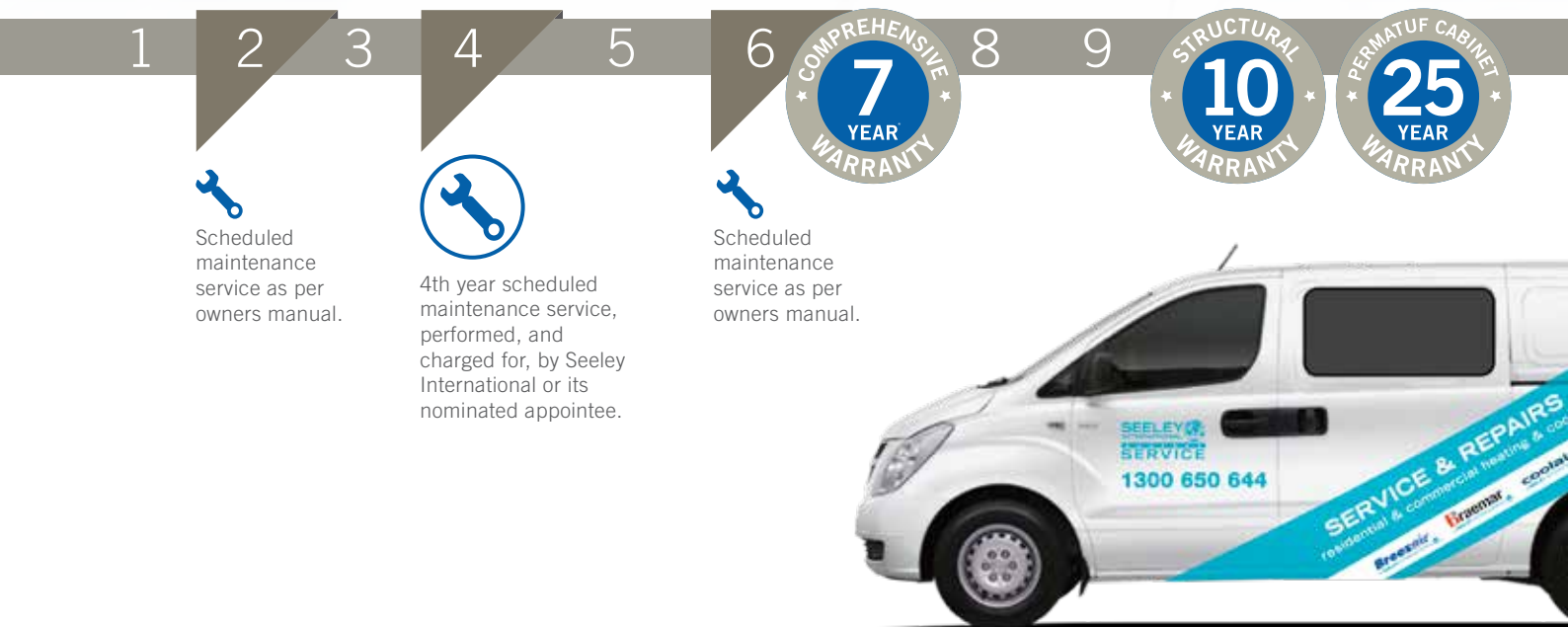

## 5 Year Warranty - Coolair<sup>20</sup>

5 year Warranty, 10 year cover on all structural components, plus a hefty 25 year cover against corrosion, on its Permatuf® cabinets.

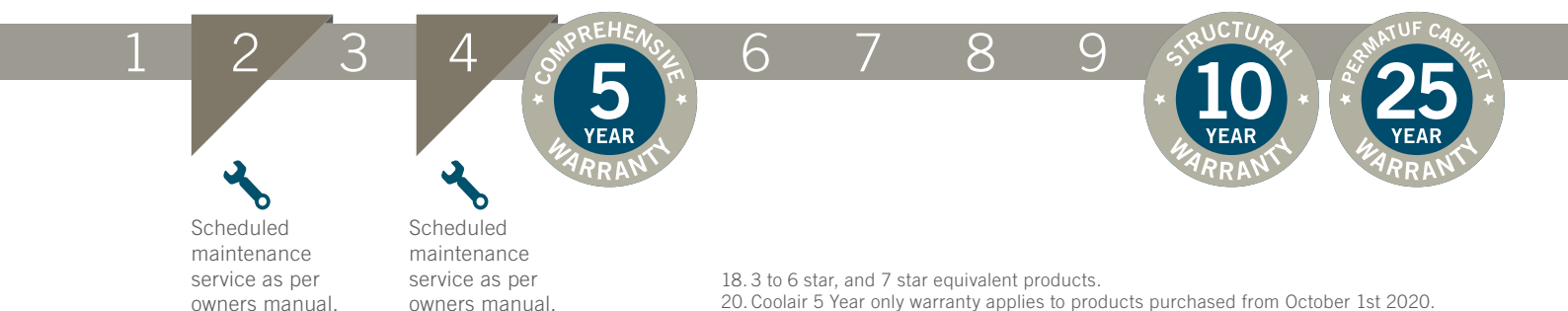

18. 3 to 6 star, and 7 star equivalent products.

20. Coolair 5 Year only warranty applies to products purchased from October 1st 2020.



Harness the *power* of nature



**GLOW CITY**  
352 Morphett Rd  
Warradale  
8397 6100

**GLOW SOUTH COAST**  
4 Victor Harbor-Goolwa Rd  
Middleton  
8554 2860

[info@glowhce.com.au](mailto:info@glowhce.com.au) | [glowhce.com.au](http://glowhce.com.au)



With the generous support of our Australasian dealers we are proud to be the National Variety Bash partner supporting kids in need across Australia.

Seeley International Pty Ltd

ABN 23 054 687 035

112 O'Sullivan Beach Road, Lonsdale, SA 5160

Phone: (08) 8328 3850

[seeleyinternational.com](http://seeleyinternational.com)

Information in this brochure was correct at the time of preparation. E & OE



FS 605002

Cat No ML01 DEALER REV C (0922)